



RADIANCE LINEAR

50-200 watt LED area luminaire
IK08 | IP54 | Suspended/ Surface Mount

Application

A solution for Trading Floors, Supermarkets, Aisles, Storage Facilities, Retail Stores, and Warehouses areas.

Features

- 50/60Hz Frequency
- Operating Temperature $-40^{\circ}\text{C} \sim 50^{\circ}\text{C}$
- 170-200lm/W Luminaire Efficacy
- <15% Total Harmonic Distortions
- Electrical Class I
- L80 B10 50 000hrs Rating
- SMD 2835 LED
- Ra80 Color Rendering Index
- DIP Switch Driver
- 3000K, 4000K, 5500K CCT
- >0.95 Power Factor
- AC100-277V Rated Voltage

Design Specifications

- ADC12 Aluminium Housing Body.
- White housing colour
- Polycarbonate Lens Diffuser
- White Housing Colour
- Top cable entry



Dimensions

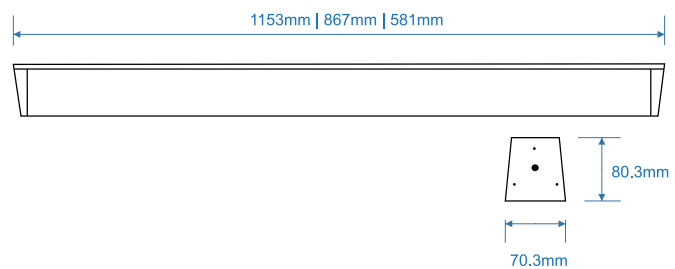

Performance



Photometric Data

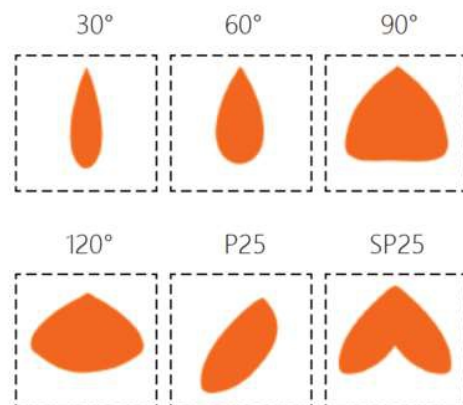

RADIANCE LINEAR

50-200 watt LED area luminaire
IK08 | IP54 | Suspended/ Surface Mount

Technical Specifications

Model No.	Input (v)	Power	Lumen lm/W	CCT (K)	CRI	Beam Angle	UGR	SDCM
	AC100-277V	50W	200	5500K	>80	120°		<3
	AC100-277V	75W	200	5500K	>80	120°		<3
	AC100-277V	100W	200	5500K	>80	120°		<3
	AC100-277V	113W	200	5500K	>80	120°		<3
	AC100-277V	150W	200	5500K	>80	120°		<3
	AC100-277V	200W	200	5500K	>80	120°		<3

Accessories



H01

Suspension Accessory(A)



H02

Suspension Accessory(B)



H03

Mounting Clip

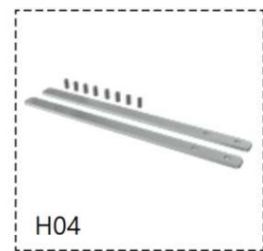

H04

Splicing pieces

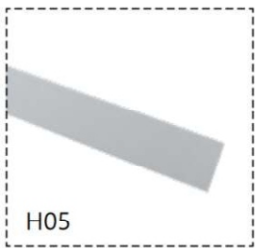

H05

Micro prismatic cover

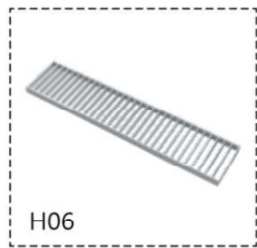

H06

Louver cover

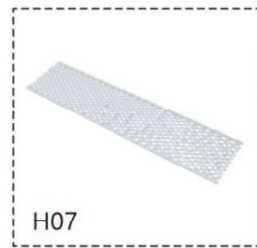

H07

small Honeycomb cover

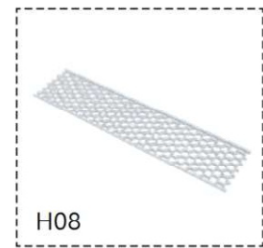

H08

big Honeycomb cover

Emergency Display

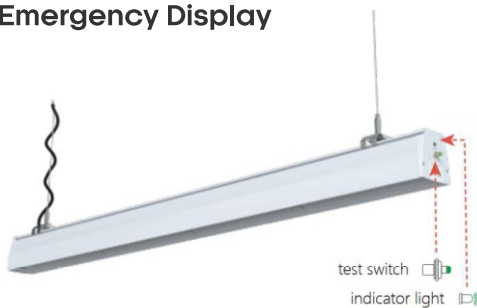

test switch
indicator light

LED Indicator Status Display:

Color	State
●	Charging Mode
○	Discharging mode or Main power disconnected

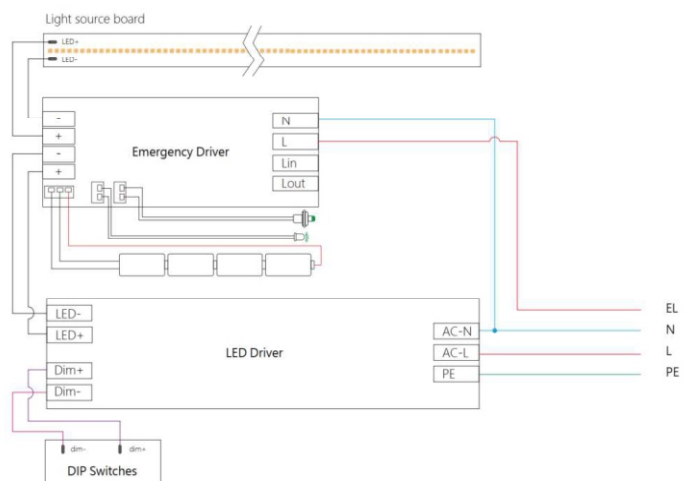

RADIANCE LINEAR

50-200 watt LED area luminaire
IK08 | IP54 | Suspended/ Surface Mount

Sensor Functions

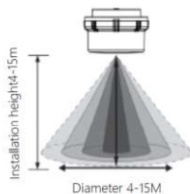

Equipped with a daylight sensor and microwave sensor, this system differs from manual switch dimming. The sensor module enables automatic dimming, improving efficiency and energy savings. It is suitable for warehouses, corridors, and garages.

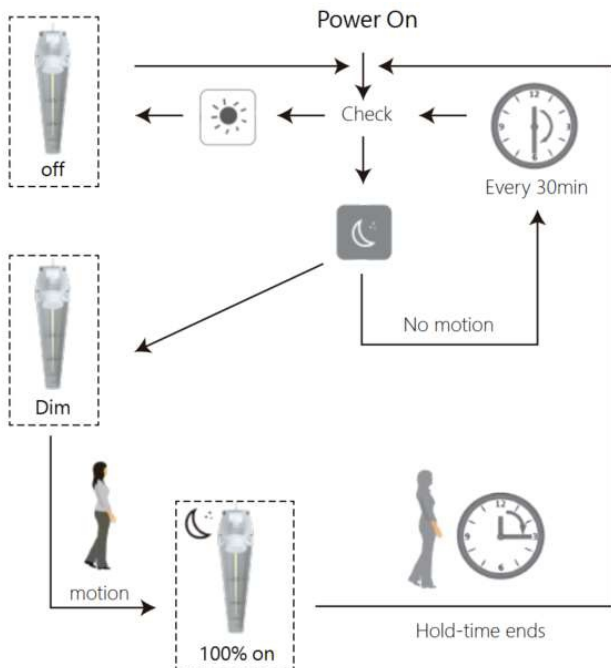
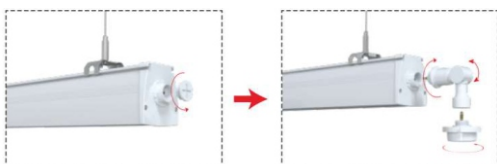

RADIANCE LINEAR



Certifications



Optional Features

- 0-10V | DALI Dimmable Options
- Microwave, Daylight Harvesting Sensor Options.
- 3Hour @ 15W Back-up Power Emergency options are available on request.



Unit 21 & 22, Brentwood Office Park,
Brentwood Park AH, Benoni.
info@lambdalumen.com
Tel: +27 10 500 9150